

Medsys s.a.

Medical Systems



**From Robotics
to Surgical
Instruments**

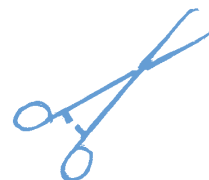
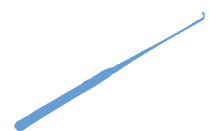
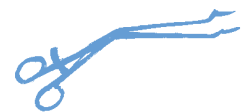

Table of Contents

A. LAPAROSCOPIC PRODUCTS	
LAPMAN®	1-2
LAP LOOP	3-4
B. SPECIALITY PRODUCTS	
NEXT 200 Monopolar/Bipolar Electrosurgical Generator	5-6
Bipolar Forceps	9
Universal Reusable and Disposable Electrodes.....	8-9
Universal Electrosurgical Accessories	8
Non-Conductive Instruments.....	7
Endometrial Samplers and Dilators	4-5
Cervix needle.....	10
Myazaki Lighted Retractors.....	10
Special Hysterectomy Clamps.....	32
C. COLPOSCOPY INSTRUMENTS	
Biopsy Forceps	12-15
Endocervical Specula	16
Endocervical and Endometrial Curettes	16
Tenacula.....	18
Cervical Hooks	18
Vaginal Specula.....	19-20
D. GYNECOLOGICAL SURGICAL INSTRUMENTS	
Sounds.....	17
Curettes	17
Uterine Cannula.....	17
Keyes Vulvar Punches	18
Lateral Vaginal Retractors	19-20
Vulsellum Forceps	21
Sponge Forceps.....	21
Scissors	19-20
Dissecting Forceps.....	22
Hemostatic Forceps	28
Hysterectomy Forceps	29-
Uterine Forceps.....	27
Retractors	33-34
Needle Holders	35-36
Monopolar Scissors.....	37
Monopolar Forceps	37



**High Quality
is
Cost
Effective !**

Dear Customer,

Since years, MEDSYS has been developing and manufacturing products in the field of women's healthcare for its growing base of customers and distributors throughout the world.

With experienced staff in high quality surgical instruments, the company aims to continue the century old tradition of cutlery and surgical instrument manufacturing - combining high quality and innovation - of the town of Gembloux, Belgium.

We are pleased to introduce our new enlarged product catalog : it focuses on electro-surgery, general surgery instruments and introduces a few very innovative laparoscopic devices developed with European opinion leaders.

It is our belief that our quality is cost effective : our reusable products will last because they are made of selected raw material, manufactured by experienced colleagues using appropriate equipment and according to international standards. MEDSYS provides a 1 year warranty on material and workmanship for all its reusable instruments and equipments, provided that the customer uses the products appropriately and applies "good maintenance practices" applicable to quality products.

MEDSYS' maintenance department provides further service for the repair of our surgical instruments and equipments. Don't hesitate to contact us for any question or troubleshooting related to the products.

As you read through this catalog, if you don't see what you need, please don't hesitate to contact our customer service department and ask for it. There is a good chance that our colleagues can accommodate your demand.

We thank you for your continued confidence and look forward serving you into the future.

Sincerely,

Xavier MOREELS
Managing Director



LapMan®

Laparoscope Manipulator

The Facts

- The quality of outcome of laparoscopic surgery is dependent upon the view of the operative site throughout the procedure.
- Today laparoscopic surgeons have to rely on assistants holding the laparoscope to provide the optimum view of the procedure.
- Even skilled assistants cannot always anticipate or interpret the surgeon's optimal view or next movement.
- Separating laparoscope and instrument control leads to delay, reduced efficacy, stress and less safe surgery.

Restores
autonomous
control
of the
operative view
to the
laparoscopic
surgeon.



Video and
publication on LapMan®
by R Polet MD available
on request

Introducing LapMan® into the Operating Room will :

- Put the surgeon back in control of vision.
- Lower surgical risks, eliminating unsolicited movements.
- Reduce overall operating time (as indicated by preliminary studies).
- Free the assistant for other tasks.
- Reduce the overall cost of laparoscopic procedures.

The LapMan® system comprises

The LapMan®

- LapMan® is reversible for laparoscopy of both the upper abdomen and pelvis making it suitable for most common surgical specialties.
- Includes many safety features.
- Maintains the sterile field with autoclavable or draped components.
- Rolling base makes positioning easy, on either side of the operating table.
- Only a single shaft crosses the patient for laparoscope management.
- Connection to laparoscope is easy and fast.

The LapMan® Remote Hand Control

Ergonomic analysis of the surgeon's movements during laparoscopic surgery indicate control of the LapMan® is easier using a remote hand control unit than a foot pedal or voice control. Foot pedals already operate electrosurgery, suction/irrigation and other functions whilst current voice recognition software remains unreliable.

The LapMan® Remote Hand Control unit is easily held in position in the palm of the hand, under the sterile glove. Six buttons activated by the middle finger, ring finger and little finger direct the laparoscope in three dimensions: in/out, up/down, left/right.

The LapMan® reacts immediately and quietly to instructions emitted by the Remote Hand Control unit, without connection by inconvenient wires.



Technical specifications

LapMan®

Weight : 50 Kgs

Dimensions :

Height : 1,2 - 1,5 m

Length : 0,7 m

Width : 0,36 m

Hand Control

Weight : 70 gr

Dimensions :

6 cm x 5 cm x 2,5 cm

Order number : 900-001 LapMan® - 900-112 Hand Control (set)

Product description :

900-001 LapMan® System

Includes : Rolling Base 230v, Arm, Shaft, Shaft Holder, HandControl Sterilisation trays, Remote Control, Accessories box, Operating manual, LapMan Training Kit

900-111 HandControl Set P

Includes : 2 HandControls, 20 Sterile Drapes, 20 Scope holders

900-112 HandControl Set N

Includes : 2 HandControls, 20 Sterile Drapes, 20 Scope holders

Lap Loop System

For laparoscopic total and subtotal hysterectomy

Safer : specifically designed system avoids possible damage by contact with surrounding tissues during sectioning.

Easier : once the Lap Loop is in place, the sectioning is performed in one single movement.

Faster : one movement replaces time consuming multiple incisions.

Video and publication of Prof. J. DEQUESNE using Lap Loop System available on request



The Lap Loop System comprises a reusable instrument and a disposable Loop.

Introducer



Sheath



Electrode



Patent pending

Procedure for use of Lap Loop System

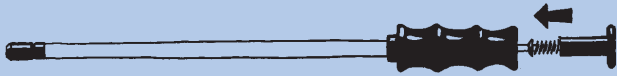

1. Insert the introducer in the sheath.



2. Push the introducer so that the distal tip extends out of the sheath and rotate the introducer to lock it in the sheath. (spring compressed)

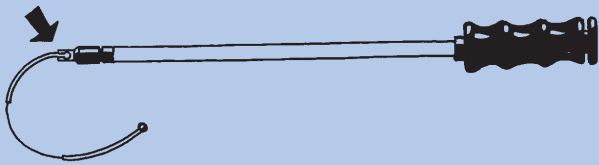

3. Screw the screw thread end of the Lap Loop electrode into the female thread at the distal tip of the introducer .



4. Unlock the introducer and pull back the introducer until the entire Loop is withdrawn inside the sheath.

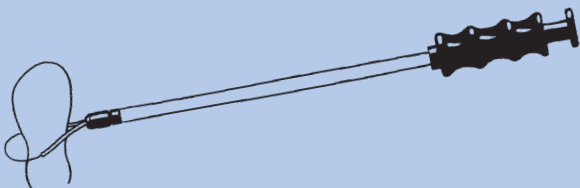

5. Insert the entire Lap Loop System through the trocar.

. Push the introducer so that the Loop is in the operating field. Compress spring, rotate and lock the introducer.

Position the Loop around the uterus.

Locate the ball end of the Loop electrode in the socket at the distal tip of the introducer, using forceps.

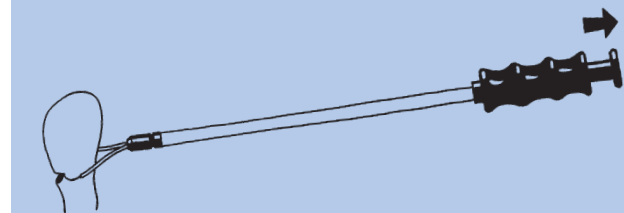

6. Rotate the introducer (spring decompressed) so that the Loop ends are completely withdrawn into the sheath.

Connect the monopolar cable adaptor and apply electrical current.

While maintaining the distal end of the sheath close to the uterus, pull back the introducer until uterus is sectioned, stop applying current and remove the monopolar cable adaptor.

Pull back the introducer until the entire Loop is in the sheath and remove sheath out of the trocar.

Remove the introducer out of the sheath, unscrew the Loop and discard it.

Order number :
 110-030 Lap Loop instrument
 120-060 Lap Loop Electrode (box of 10)

Next 200



The Next Mono-Bipolar ElectroSurgical System for clinics, offices and operating rooms

Unique Single Pulse ■
Repeat Pulse ■
Super Pulse Modes ■

Less heat diffusion ■
Many applications ■
Easy to operate ■

GYNAECOLOGY / DERMATOLOGY / GENERAL SURGERY /
ENT / PLASTIC SURGERY

Next200

Specifications and Accessories



Next200 Accessories

Technical Data

Input Voltage.....	220-240 Vac 50-60Hz
RF Output Frequency.....	1,750 MHz
Working	temporary
RF Output Power (Cut1-Cut2-Coag1).....	200 Watt EFF. max (±20%)
RF Output Power (Coag2)	130 Watt EFF. max (±20%)
Output impedance.....	125 Ohm Coag1-Bipolar
Output impedance.....	475 Ohm Cut1-Cut2-Coag2
Bipolar output circuit.....	floating at high insulation
Monopolar output circuit.....	ground closed for H.F.
H.F. leakage current	<150mA
Input power.....	350 V.A. max
Line protection.....	2 ultrafast fuses 2A
Internal protection	1 fuse 4A, 1 fuse 1A
Commands	double footswitch
Power control	from 3 to 200 units
Function.....	(Cut 1-2 Coag 1-2)
Power selection.....	independent for Cut and Coag
Emission mode	4 emission modes
Protection Class	I type BF-IPX1
Size.....	460x340x150mm
Weight.....	11Kg 500

Test circuit for reference plate

According to : EN60601-1
 EN60601-2 EN60601-1-2 EN60601-2-2 EN 55011
 IEC801-3 EN 61000-4-2 EN61000-4-4 EN61000-4-5

Non-Conductive Electrosurgical Instruments & Specula

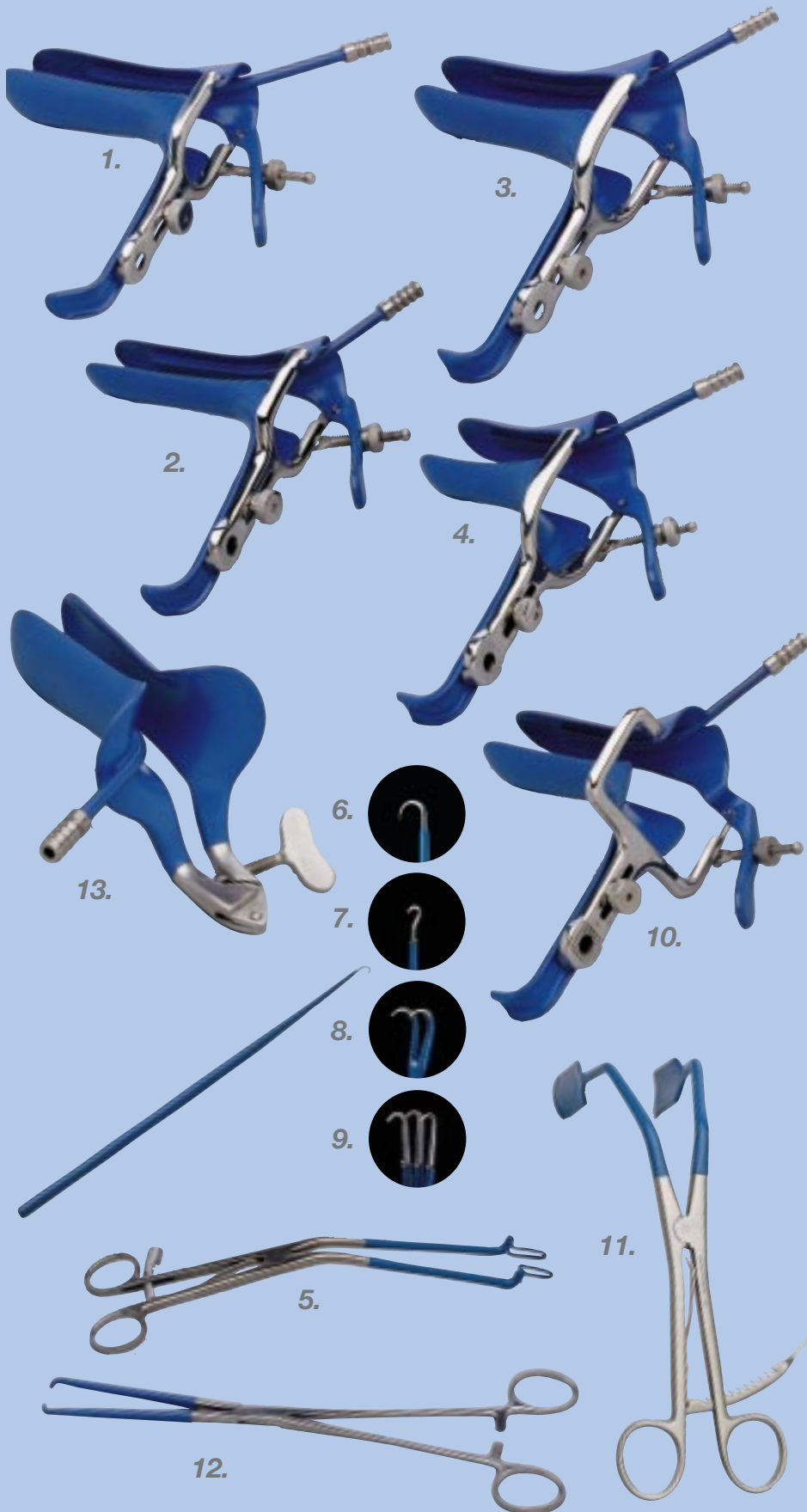

- 1.** Graves Speculum with smoke tube
Item n°130-100 (Lg.)
Item n°130-101 (Med.)
Item n°130-102 (Sml.)
- 2.** Pederson Speculum with smoke tube
Item n°130-103 (Lg.)
Item n°130-104 (Med.)
Item n°130-105 (sml.)
- 3.** See-More Speculum with smoke tube Item n°130-110 (Lg.)
Item n°130-111 (Med.)
Item n°130-109 (Sml.)
- 4.** Mini See-More Speculum with smoke tube
Item n°130-113
Blade Size: L 70 x W 30mm
- 5.** Kogan Endocervical Speculum
Item n°130-130 (5mm, tips)
Item n°130-131 (4mm, tips)
Item n°133-132 (6mm, tips)
- 6.** Emmett Hook Item n°130-151
- 7.** Iris Hook Item n°130-150
- 8.** Two-Prong Hook Item n°130-154
- 9.** Three-Prong Hook Item n°130-155
- 10.** See-More Speculum with smoke tube
Item n°130-112 (XL)
- 11.** Lateral Vaginal Retractor
Item n°130-141
- 12.** Schroeder Tenaculum
Item N°130-160 (Exposed tips)
Item n°130-161 (coated tips)
- 13.** Collin Speculum with smoke tube
Item n°130-120 (Sml.)
Item n°130-121 (Med.)
Item n°130-122 (Lg.)

- All specula incorporate a smoke evacuation tube.
- All instruments are protected by the highest quality, fully autoclavable blue coating.

All these coated instruments are also available in black (anti-reflexion) for use with lasers.

Universal Electrosurgical Electrodes and Accessories

Reusable Handle
Foot Activated



Item n°110-006



Item n°110-007

Reusable Handle
Hand Activated



Item n°110-014

Pincer Cable
for interconnection
(Specificity E.S. Generator)
Item n°110-009



Disposable
Dispersive Pads
(box of 10)
Item n°110-008

* Sterile
disposable
Item #

Reusable
Item #

120-001

120-001 R

0,3 cm dia x 13 cm Shaft

120-002

120-002 R

0,5 cm dia x 13 cm Shaft

120-010

120-010 R

Needle 0.8 mm dia x16 mm x 13 cm Shaft

120-011

120-011 R

Needle 0.8 mm dia x16 mm x 13 cm Shaft

120-020

120-020 R

1.0 cm x 0.5 cm x 13 cm Shaft

120-021

120-021 R

1.0 cm x 1.0 cm x 13 cm Shaft

120-022

120-022 R

1.5 cm x 0.8 cm x 13 cm Shaft

120-026

120-026 R

1.5 cm x 1.5 cm x 13 cm Shaft

120-023

120-023 R

2.0 cm x 0.8 cm x 13 cm Shaft

120-033

120-033 R

2.0 cm x 1.0 cm x 13 cm Shaft

120-027

120-027 R

2.0 cm x 1.3 cm x 13 cm Shaft

120-024

120-024 R

2.0 cm x 1.5 cm x 13 cm Shaft

120-028

120-028 R

2.0 cm x 2.0 cm x 13 cm Shaft

120-030

120-030 R

1.0 cm x 0.4 cm x 5.5 cm Shaft

120-031

120-031 R

1.0 cm x 0.8 cm x 13 cm Shaft

120-032

120-032 R

1.0 cm x 0.4 cm x 13 cm Shaft

120-042

120-042 R

13 cm Blade

ElectroSurgical Bipolar Forceps



180-101
1 mm
19 cm



180-100
Pointed
19 cm



180-110
1 mm
19 cm



180-111
2 mm
19 cm



180-120
Pointed
19 cm



180-121
1 mm
19 cm



180-122
2 mm
19 cm

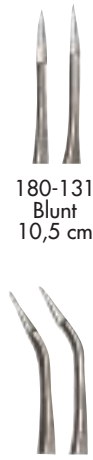

180-131
Blunt
10,5 cm



180-140
Pointed
10,5 cm



180-141
Blunt
10,5 cm



180-130
Pointed
10,5 cm



180-200

- Highest quality
- Autoclavable at 134°C
- Guide stop for permanent alignment
- European standard flat-connector
- Non-conductive coating
- For precise surgery
- Autoclavable cable with small plugs

- Individually packed non sterile
- Autoclavable
- Available sterile disposable on request

Illustrations show approximate size

ElectroSurgical Reusable Electrodes

Ball Electrodes



125-001 Ø 3 mm Total length 5cm



125-002 Ø 5 mm Total length 5cm

Needle Electrodes



125-011 Fine Ø 0,8 mm x 17 mm Total length 7cm



125-011A Fine Ø 0,8 mm x 17 mm Angled



125-016 Ø 1 mm



125-016MF Ø 1 mm



125-017 Ø 1,7 mm

Ring Electrodes



125-025 Ø 5 mm Shaft length 4,5cm



125-020 Ø 6 mm Shaft length 4,5cm

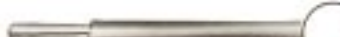

125-021 Ø 8 mm Shaft length 4,5cm



125-022 Ø 10 mm Shaft length 4,5cm



125-023 Ø 12 mm Shaft length 4,5cm



125-026 Ø 15 mm Shaft length 4,5cm



125-024 Ø 20 mm Shaft length 4,5cm

Blade Electrodes



125-040 Blade Total length 7cm



125-040MF Blade Total length 7cm



125-041 Blade Total length 7cm

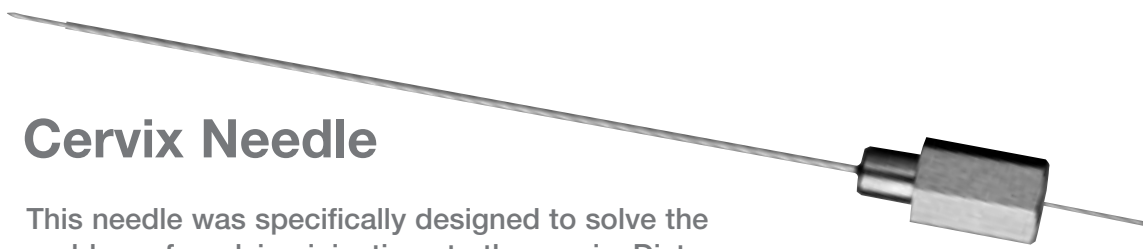

Cervix Needle

This needle was specifically designed to solve the problem of applying injections to the cervix. Distance and tough cervical tissue can make injection difficult with standard needles. With its reinforced and extended shaft, the Cervix Needle makes cervical application an easy procedure.

The Cervix Needle only attaches to a "dental style" cartridge syringe.

Item n° 606-600

Box of 6

Available on request :
cartridge Syringe

Item n° 607-000

Miyazaki Lighted Retractors

- Light the way to the surgical site
- The Breisky shape with procedure specific tips
- Come complete with 300 cm Fiber optic cord and customized tips

Miyazaki All Purpose Retractor

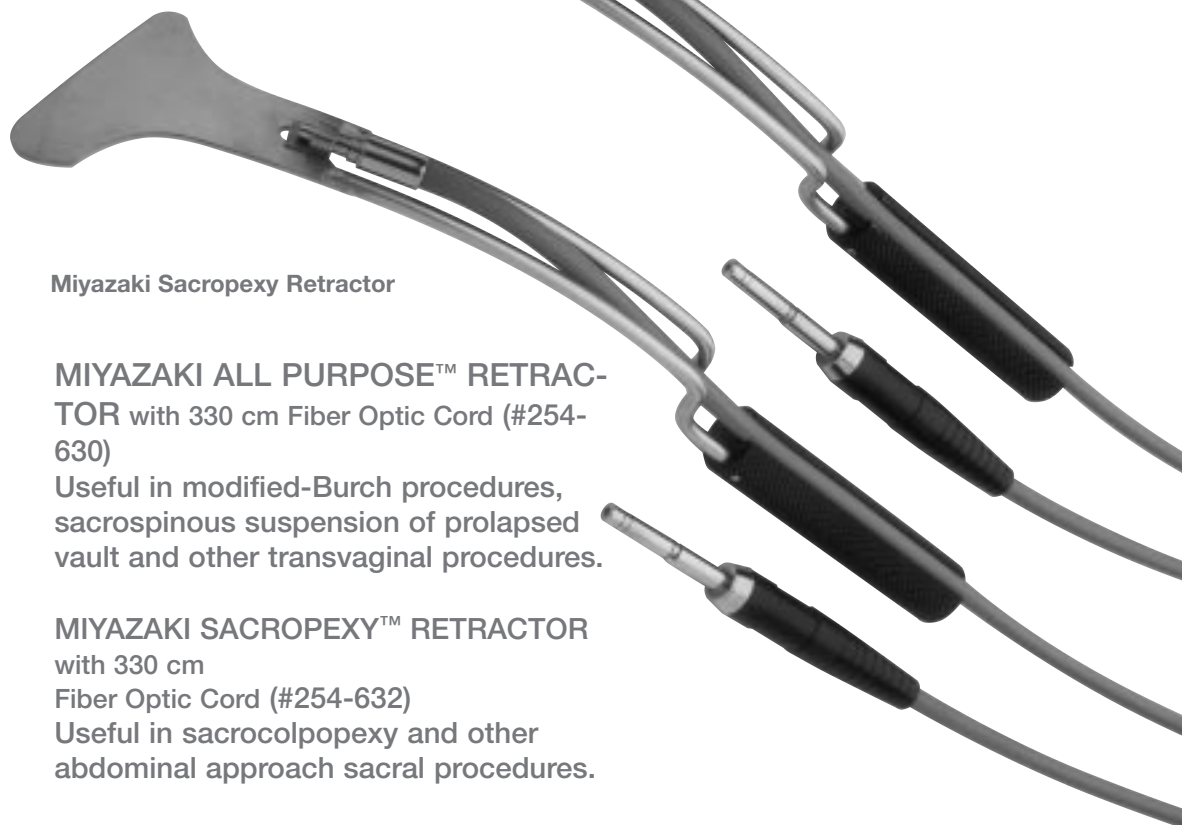

Miyazaki Sacropexy Retractor

MIYAZAKI ALL PURPOSE™ RETRAC-
TOR with 330 cm Fiber Optic Cord (#254-630)

Useful in modified-Burch procedures, sacrospinous suspension of prolapsed vault and other transvaginal procedures.

MIYAZAKI SACROPEXY™ RETRAC-
TOR with 330 cm

Fiber Optic Cord (#254-632)

Useful in sacrocolpopexy and other abdominal approach sacral procedures.

Endometrial Samplers and dilators



MES (Medsys Endometrial Sampler) (280-725)

- For maximum patient safety and comfort
- Optimum sample recovery
- 3mm plus O.D. for ample biopsy
- Double O-ring mechanism assures optimal suction

MES (Medsys Endometrial Sampler with Syringe) (280-655)

- Randall-like cutting edge assures sample
 - Syringe provides extra vacuum
 - Convenient 3mm O.D
- Angled for left or right cornual selection

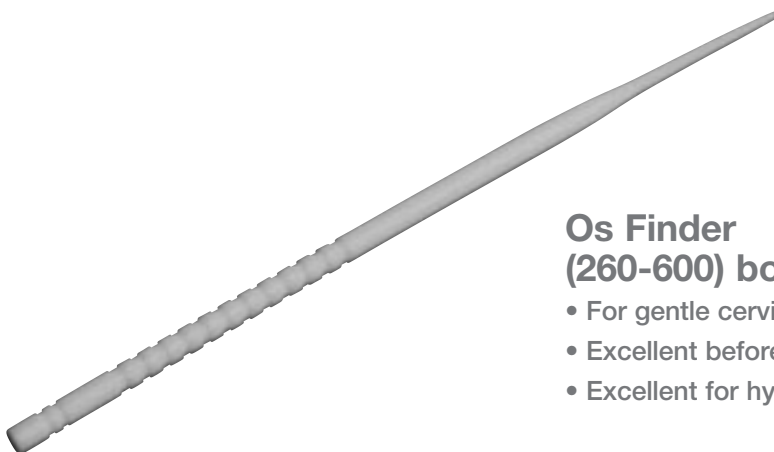
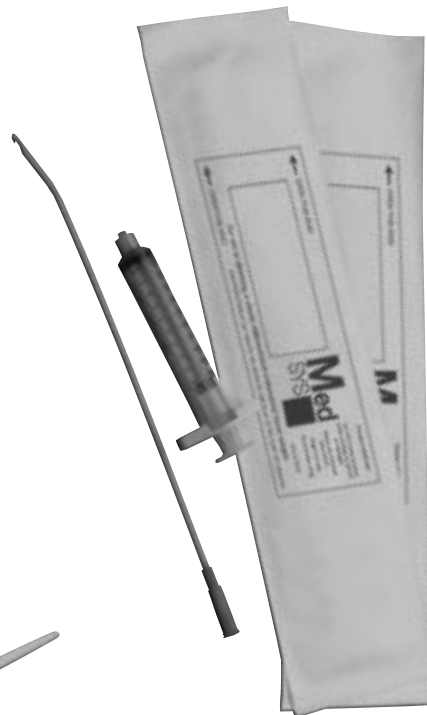

Os Finder (260-600) box of 50

- For gentle cervical canal dilation
- Excellent before endometrial sampling
- Excellent for hysteroscope introduction

Biopsy forceps



Working Length : 20 cm



○ 7x3 mm
TISCHLER
Item n°160-170



□ 3x9 mm
KEVORKIAN
Item n°160-172



□ 2,3x4 mm
BABY TISCHLER
Item n°160-171



○ 3x5 mm
BURKE STYLE
Item n°160-174

■ Available on request :



7mmx3mm
Item n°160-175



4mmx2,3mm
Item n°160-176



6,5mmx4mm
Item n°160-177

Biopsy forceps with rotating shaft

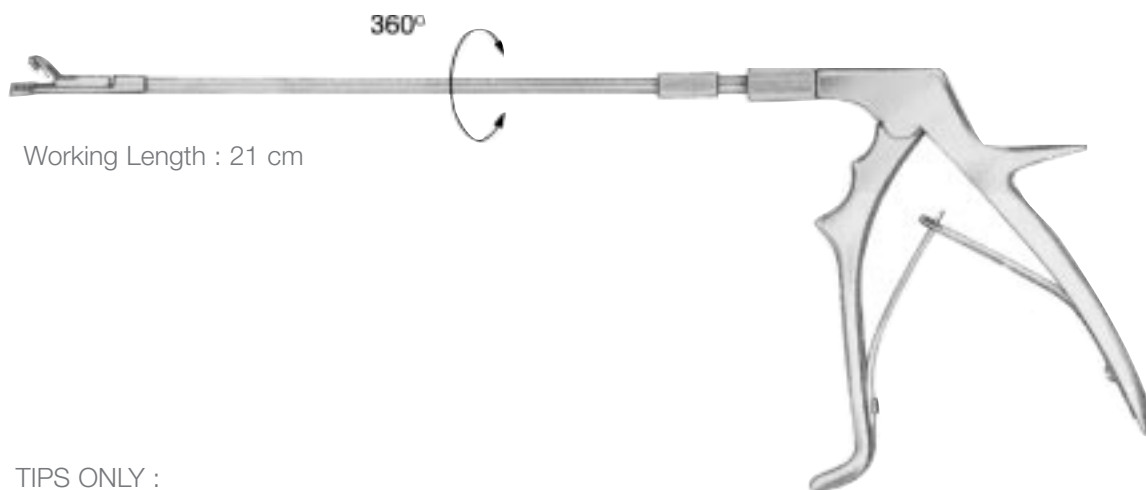

Working Length : 21 cm

TIPS ONLY :

- Item n°160-181 KEVORKIAN
- Item n°160-182 TISCHLER
- Item n°160-183 BABY TISCHLER
- Item n°160-184 OVAL

HANDLE ONLY :

- Item n°160-180



3x7 mm 
TISCHLER
Item n°160-186



 3x9 mm
KEVORKIAN
Item n°160-185



 2,3x4 mm
BABY TISCHLER
Item n°160-187



 3x5 mm
OVAL
Item n°160-188

Biopsy Forceps

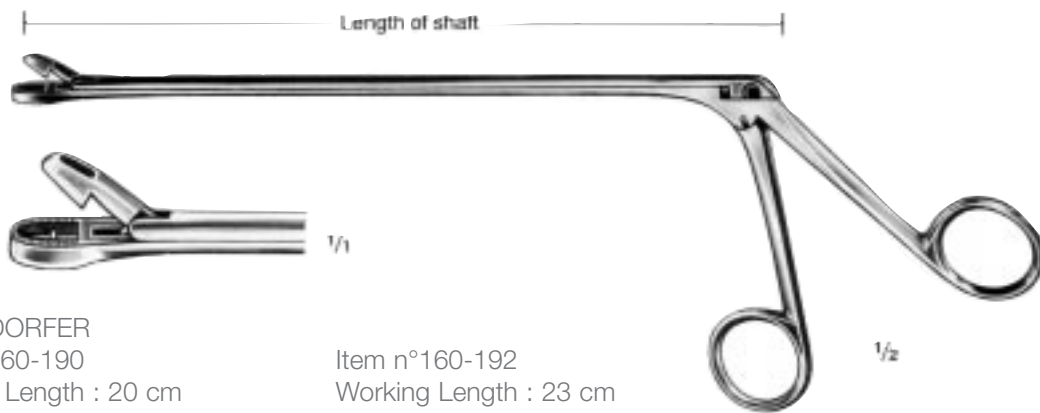

EPPENDORFER
Item n°160-190
Working Length : 20 cm

Item n°160-192
Working Length : 23 cm

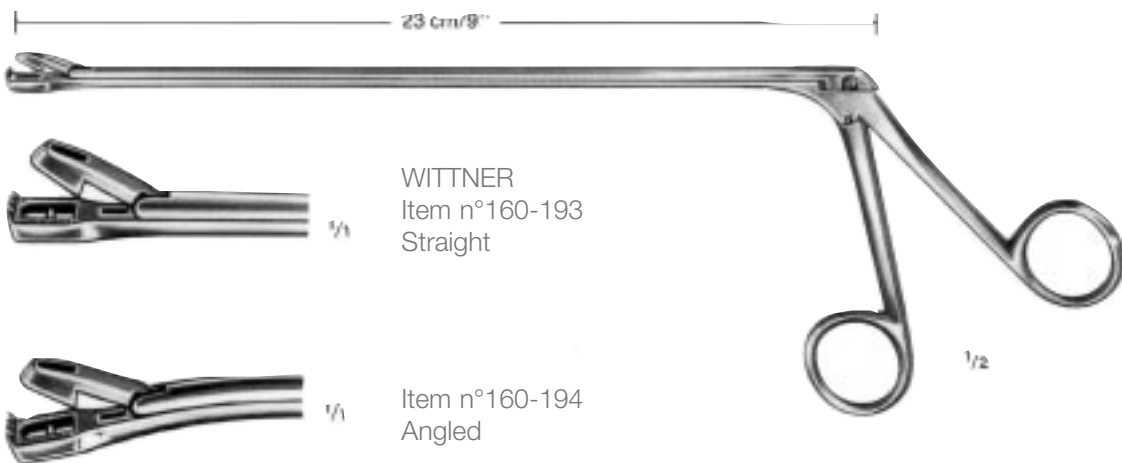

WITTNER
Item n°160-193
Straight

Item n°160-194
Angled

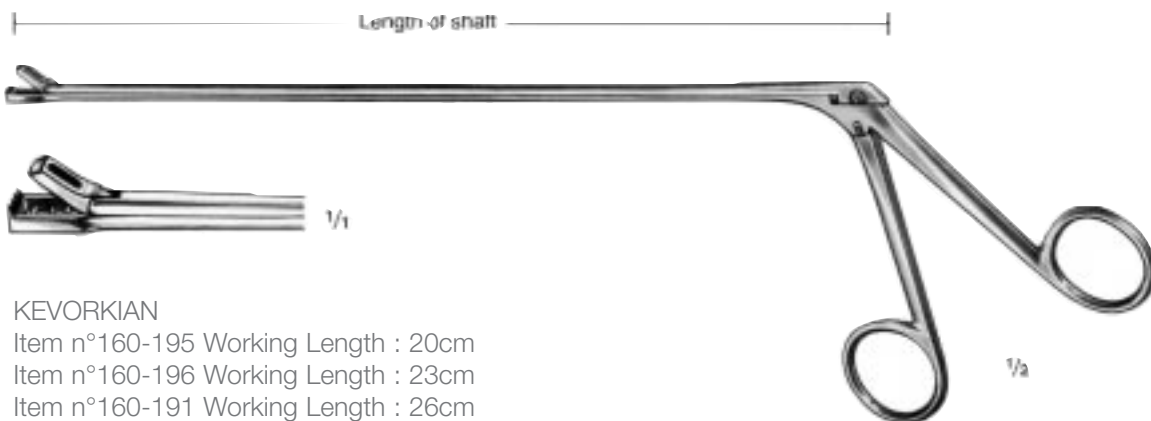

KEVORKIAN
Item n°160-195 Working Length : 20cm
Item n°160-196 Working Length : 23cm
Item n°160-191 Working Length : 26cm

Biopsy forceps



SCHUBERT
Item n°160-201
Working Length : 20 cm



SCHUBERT
Item n°160-202 21 cm
Item n°160-203 29 cm



VAN DOREN
Item n°160-205 24 cm
With Ratchet



VAN DOREN
Item n°160-204
24 cm

Endocervical and endometrial curettes

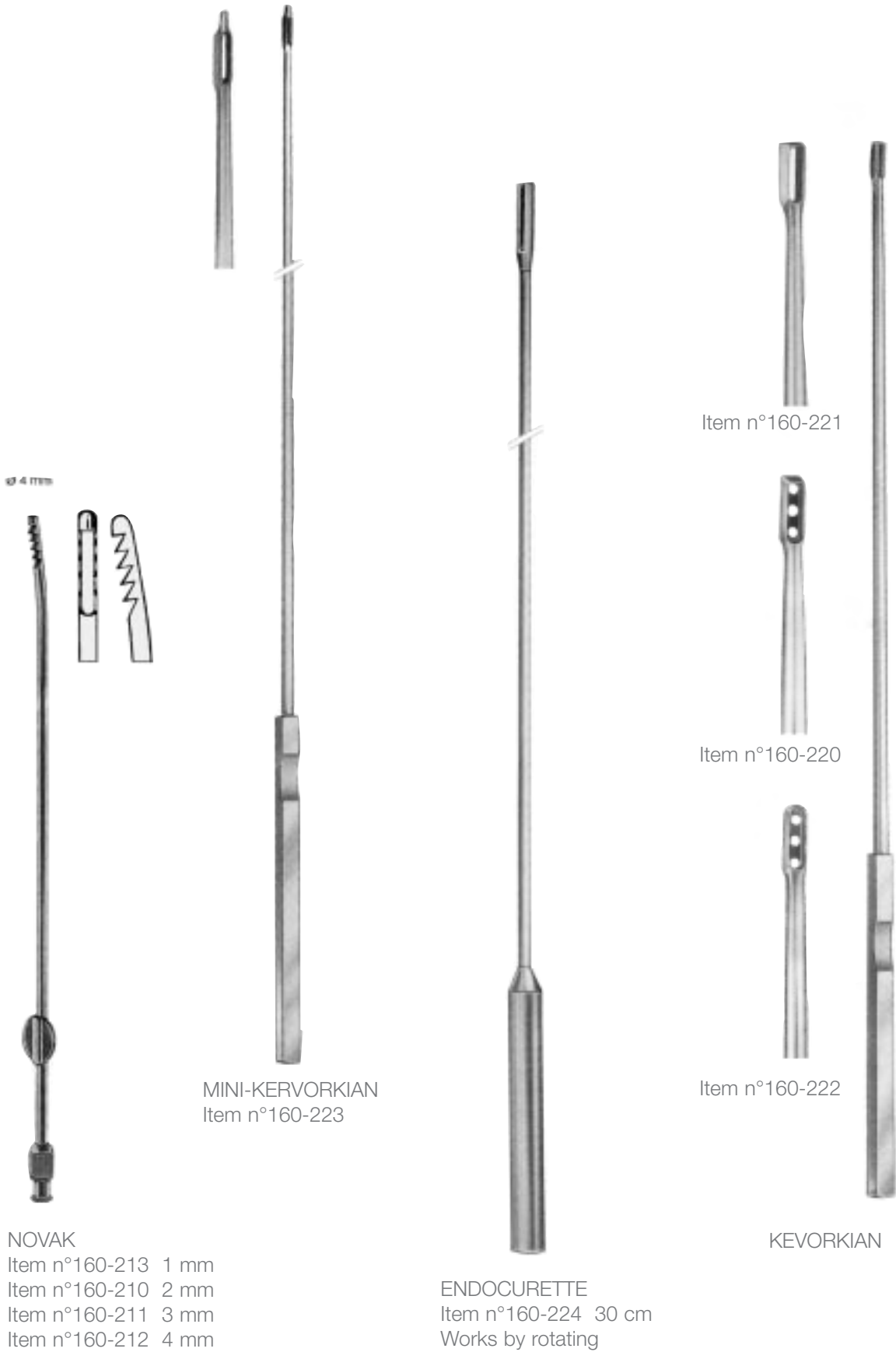

NOVAK
 Item n°160-213 1 mm
 Item n°160-210 2 mm
 Item n°160-211 3 mm
 Item n°160-212 4 mm

MINI-KERVORKIAN
 Item n°160-223

ENDOCURETTE
 Item n°160-224 30 cm
 Works by rotating

Item n°160-221

Item n°160-220

Item n°160-222

KERVORKIAN

Uterine curettes and sounds

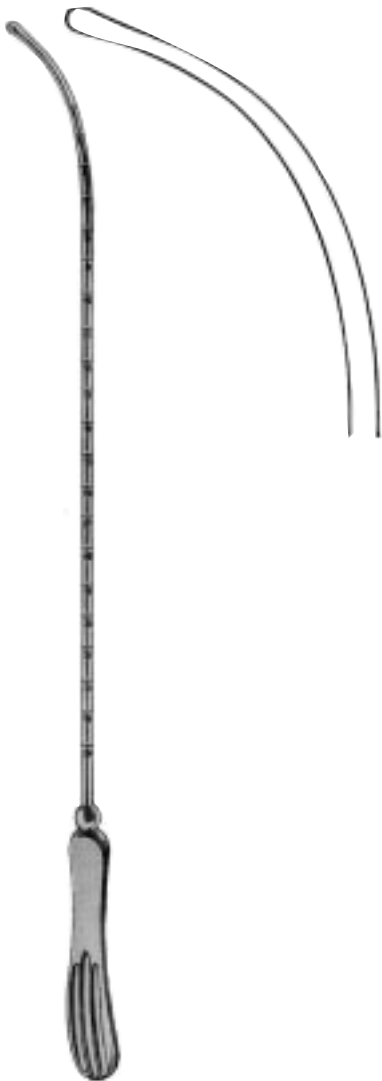

SIMS
With graduation in cm
Item n°160-298 Malleable 32 cm
Item n°160-299 Rigid 32 cm



Fig 1



Fig 2



Fig 3



Fig 4



Fig 5



Fig 6



SIMS
24,5-26 cm long
Sharp

	Rigid	Malleable
Item n° 160-250	fig.1 : 7mm	160-256
Item n° 160-251	fig.2 : 8mm	160-257
Item n° 160-252	fig.3 : 9mm	160-258
Item n° 160-253	fig.4 : 11mm	160-259
Item n° 160-254	fig.5 : 12mm	160-260
Item n° 160-255	fig.6 : 14mm	160-261



COHEN UTERINE CANNULA
Item n°160-169 - Complete with two cones
Item n°160-169 A - Cone diam. 19,0mm/3,0mm
Item n°160-169 B - Cone diam. 25,0mm/3,0mm

Tenaculum forceps and hooks



SCHROEDER
Item n°160-160
25 cm



BRAUN
Item n°160-161
25 cm

KEYES VULVAR PUNCHES



- Item n°160-402 2 mm
- Item n°160-403 3 mm
- Item n°160-404 4 mm
- Item n°160-405 5 mm
- Item n°160-406 6 mm
- Item n°160-408 8 mm
- Item n°160-400 SET
Six sizes 2-8 mm

HOOKS



EMMET
Item n°160-151



LASER IRIS
Item n°160-153



IRIS
Item n°160-150



Item n°160-154
Two-Prong Hook



Item n°160-155
Three-Prong Hook

Lateral vaginal retractor and speculums

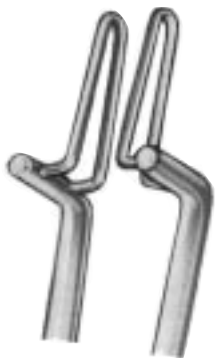

Item n°160-132
5mm

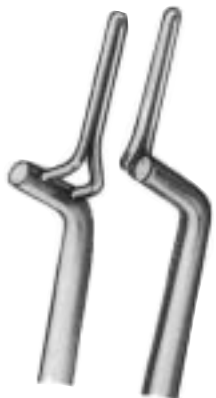

Item n°160-130
3 mm



KOGAN
Item n°160-131
4 mm



LATERAL VAGINAL RETRACTOR
Item n°160-141



COLLIN
Item n°160-120 Small
Item n°160-121 Medium
Item n°160-122 Large

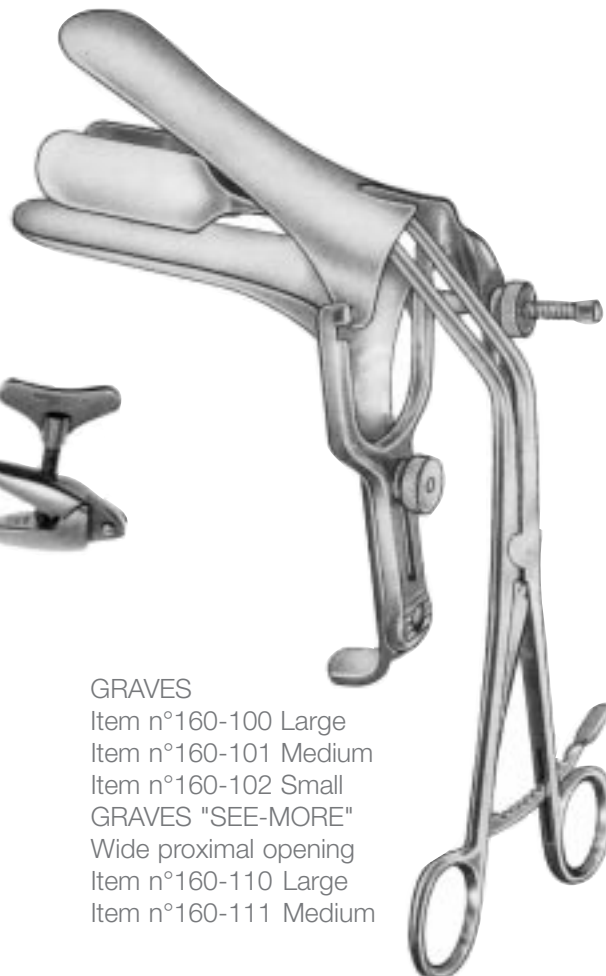

GRAVES
Item n°160-100 Large
Item n°160-101 Medium
Item n°160-102 Small
GRAVES "SEE-MORE"
Wide proximal opening
Item n°160-110 Large
Item n°160-111 Medium

Lateral vaginal retractor and speculums



CUSCO		Item n°	
a mm	b mm		
75	17	160-127	Virgin Size



CUSCO		Item n°	
a mm	b mm		
75	32	160-124	Small
85	35	160-125	Medium
100	35	160-126	Large



Redundant wall retractor
Item n° 160-140

Vulsellum and sponge forceps



MUSEUX
 Item n°040-001 # 1
 Item n°040-002 # 2
 Item n°040-003 # 3
 24 cm



FOERSTER
 Item n°040-024
 24 cm



FOERSTER
 Item n°040-124
 24 cm



BOZEMANN
 Item n°040-226
 26 cm



DESJARDIN
 Item n°160-134
 23 cm



MAIER
 Item n°040-326 straight
 Item n°040-426 curved
 26 cm

Scissors



blunt/blunt straight
 Item n°000-013 13 cm
 Item n°000-014 14 cm
 Item n°000-015 15 cm
 Item n°000-016 16 cm
 Item n°000-018 18 cm



sharp/sharp straight
 Item n°000-113 13 cm
 Item n°000-114 14 cm
 Item n°000-115 15 cm
 Item n°000-116 16 cm
 Item n°000-118 18 cm



sharp/blunt straight
 Item n°000-213 13 cm
 Item n°000-214 14 cm
 Item n°000-215 15 cm
 Item n°000-216 16 cm
 Item n°000-218 18 cm



blunt/blunt curved
 Item n°000-313 13 cm
 Item n°000-314 14 cm
 Item n°000-315 15 cm
 Item n°000-316 16 cm
 Item n°000-318 18 cm



sharp/sharp curved
 Item n°000-413 13 cm
 Item n°000-414 14 cm
 Item n°000-415 15 cm
 Item n°000-416 16 cm
 Item n°000-418 18 cm



sharp/blunt curved
 Item n°000-513 13 cm
 Item n°000-514 14 cm
 Item n°000-515 15 cm
 Item n°000-516 16 cm
 Item n°000-518 18 cm

Scissors



METZENBAUM
(LAHEY)
Item n° 003-015
14cm



METZENBAUM
(LAHEY)
Item n° 003-115
14cm



METZENBAUM
Item n°
003-018-18cm
Item n°
003-020-20cm



METZENBAUM
Item n°
003-118-18cm
Item n°
003-120-20cm



RAGNELL (KILNER)
Item n° 003-913 - 13cm
Item n° 003-915 - 15cm



BRAUN-STADLER
Item n° 003-815 - 15cm



BRAUN-STADLER
Item n° 003-821 - 21cm

Scissors



MAYO
 Item n° 000-614 - 14cm
 Item n° 000-615 - 15,5cm
 Item n° 000-617 - 17cm
 Item n° 000-623 - 23cm



MAYO-STILLE
 Item n° 000-815 - 15cm
 Item n° 000-817 - 17cm
 Item n° 000-823 - 23cm



MAYO
 Item n° 000-714 - 14cm
 Item n° 000-715 - 15,5cm
 Item n° 000-717 - 17cm
 Item n° 000-723 - 23cm



MAYO-STILLE
 Item n° 000-915 - 15cm
 Item n° 000-917 - 17cm
 Item n° 000-923 - 23cm

Scissors



IRIS Standard
Straight
Item n°002-009 9,0 cm
Item n°002-010 10,5 cm
Item n°002-011 11,5 cm
Item n°002-012 12,5 cm

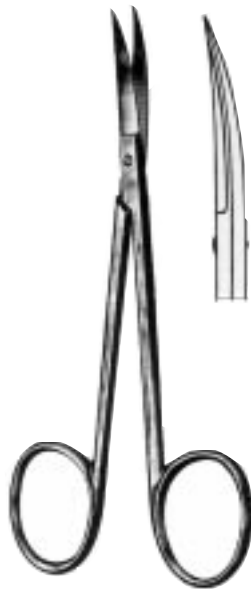

IRIS Standard
Curved
Item n°002-109 9,0 cm
Item n°002-110 10,5 cm
Item n°002-111 11,5 cm
Item n°002-112 12,5 cm

SIMS
sharp/sharp straight
Item n°001-220 20,0 cm
Item n°001-221 21,5 cm
Item n°001-223 23,0 cm



SIMS
sharp/blunt straight
Item n°001-120 20,0 cm
Item n°001-121 21,5 cm
Item n°001-123 23,0 cm



SIMS
blunt/blunt straight
Item n°001-020 20,0 cm
Item n°001-021 21,5 cm
Item n°001-023 23,0 cm



SIMS
blunt/blunt curved
Item n°001-320 20,0 cm
Item n°001-321 21,5 cm
Item n°001-323 23,0 cm



SIMS
sharp/blunt curved
Item n°001-520 20,0 cm
Item n°001-521 21,5 cm
Item n°001-523 23,0 cm



SIMS
sharp/sharp curved
Item n°001-420 20,0 cm
Item n°001-421 21,5 cm
Item n°001-423 23,0 cm



Parametrium Scissors

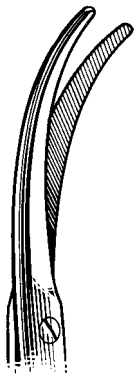

Strongly Curved w/ Gold Rings
 410-223 23cm
 410-226 26.5cm
 410-230 30cm

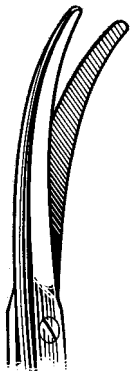

Slightly Curved w/ Gold Rings
 410-123 23cm
 410-126 26.5cm
 410-130 30cm

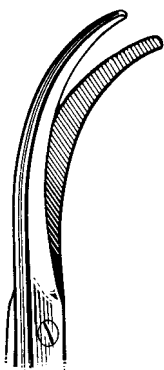

Angulated w/ Gold Rings
 410-323 23cm
 410-326 26.5cm
 410-330 30cm

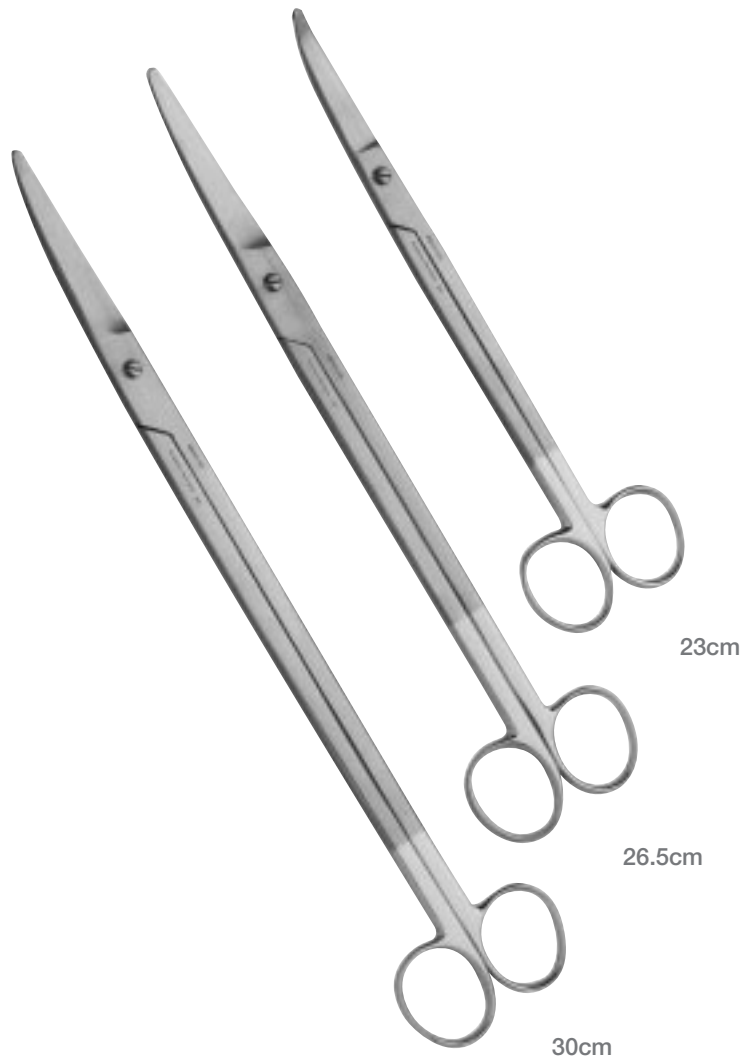

Parametrium scissors are a complete set of parametrium scissors designed to match precisely to the hysterectomy clamp jaw curvatures. The scissors guarantee precise cutting. The scissors feature a tungsten blade and a serrated blade to ensure grip during cutting. The scissors are available in three lengths and three jaw configurations.

Dissecting forceps

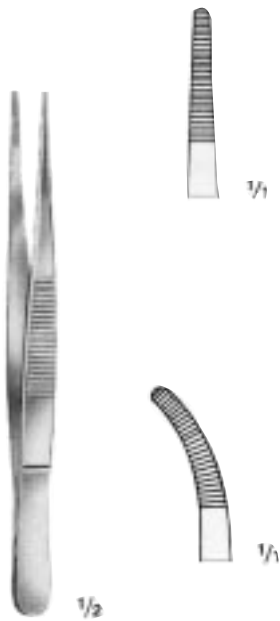

Straight
 Item n°010-011 11,5 cm
 Item n°010-013 13,0 cm
 Item n°010-014 14,5 cm
 Item n°010-016 16,0 cm
 Item n°010-018 18,0 cm
 Item n°010-020 20,0 cm
 Item n°010-023 23,0 cm
 Item n°010-025 25,0 cm
 Item n°010-030 30,0 cm

Curved
 Item n°011-011 11,5 cm
 Item n°011-013 13,0 cm
 Item n°011-014 14,5 cm
 Item n°011-016 16,0 cm
 Item n°011-018 18,0 cm
 Item n°011-020 20,0 cm
 Item n°011-023 23,0 cm
 Item n°011-025 25,0 cm
 Item n°011-030 30,0 cm

Straight
 Item n°012-011 11,5 cm
 Item n°012-013 13,0 cm
 Item n°012-014 14,5 cm
 Item n°012-016 16,0 cm
 Item n°012-018 18,0 cm
 Item n°012-020 20,0 cm
 Item n°012-025 25,0 cm
 Item n°012-030 30,0 cm

Curved
 Item n°013-011 11,5 cm
 Item n°013-013 13,0 cm
 Item n°013-014 14,5 cm
 Item n°013-016 16,0 cm
 Item n°013-018 18,0 cm
 Item n°013-020 20,0 cm
 Item n°013-025 25,0 cm
 Item n°013-030 30,0 cm



DE BAKEY

Item n°014-016 16,0 cm
 Item n°014-020 20,0 cm
 Item n°014-024 24,0 cm

Item n°015-016 16,0 cm
 Item n°015-020 20,0 cm
 Item n°015-024 24,0 cm
 Item n°015-030 30,0 cm

Hemostatic forceps



CRILE
Item n°
020-010 020-011
14cm 14cm



RANKIN-CRILE
Item n°
020-410 020-411
16cm 16cm



CRILE
Item n°
020-012 020-013
14cm 14cm
1x2 teeth



RANKIN-CRILE
Item n°
020-412 020-413
16cm 16cm
1x2 teeth



HALSTED-MOSQUITO
Item n°
020-002 020-004
12,5cm 12,5cm



HALSTED-MOSQUITO
Item n°
020-003 020-005
14cm 14cm



HALSTED-MOSQUITO
Item n°
020-006 020-008
12,5cm 12,5cm
1x2 teeth

Hemostatic forceps

ROCHESTER-PEAN

Straight - droites

- Item n°020-016 16,0 cm
- Item n°020-018 18,0 cm
- Item n°020-020 20,0 cm
- Item n°020-022 22,0 cm
- Item n°020-024 24,0 cm
- Item n°020-026 26,0 cm

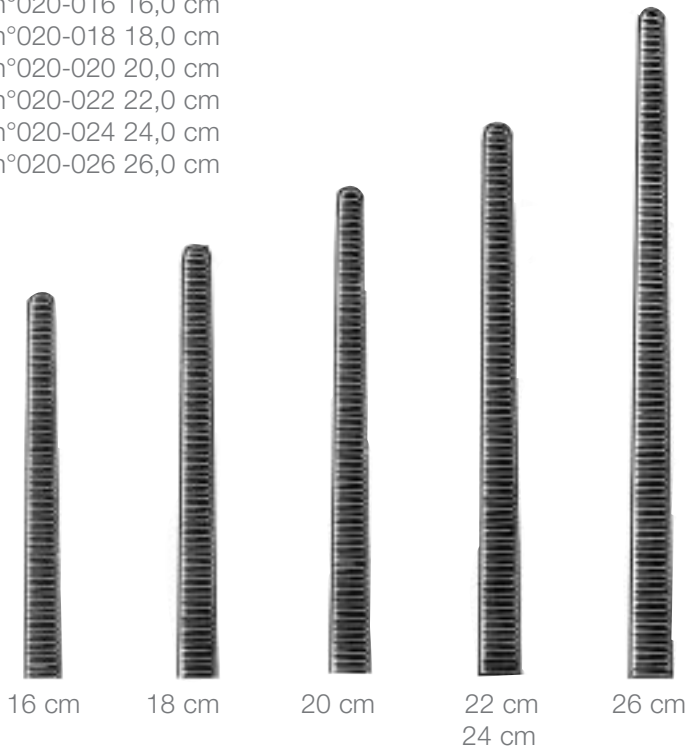

ROCHESTER-PEAN

Curved - courbes

- Item n°020-116 16,0 cm
- Item n°020-118 18,0 cm
- Item n°020-120 20,0 cm
- Item n°020-122 22,0 cm
- Item n°020-124 24,0 cm
- Item n°020-126 26,0 cm

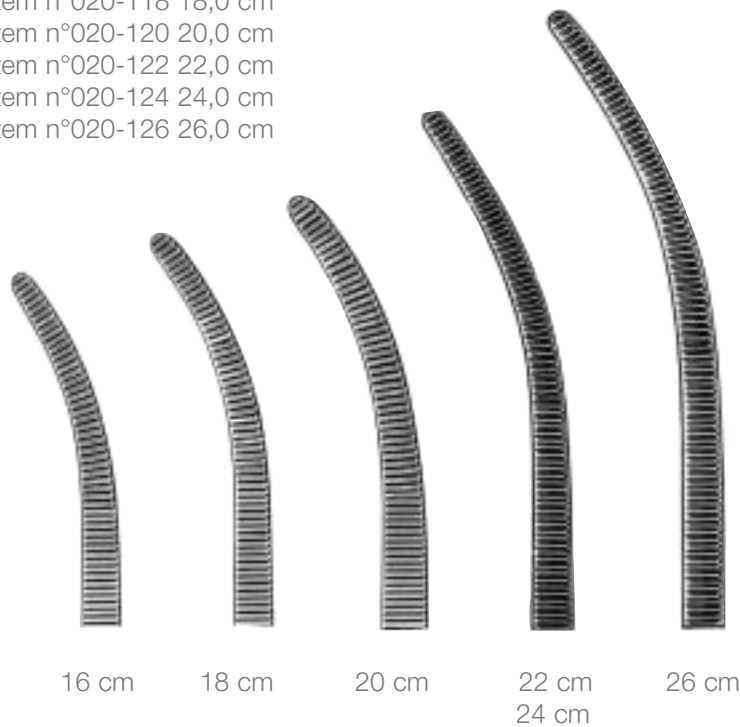

Hemostatic forceps

KOCHER

Straight - droites

Item n°020-216 16,0 cm

Item n°020-218 18,0 cm

Item n°020-220 20,0 cm

Item n°020-222 22,0 cm

Item n°020-224 24,0 cm

Item n°020-226 26,0 cm

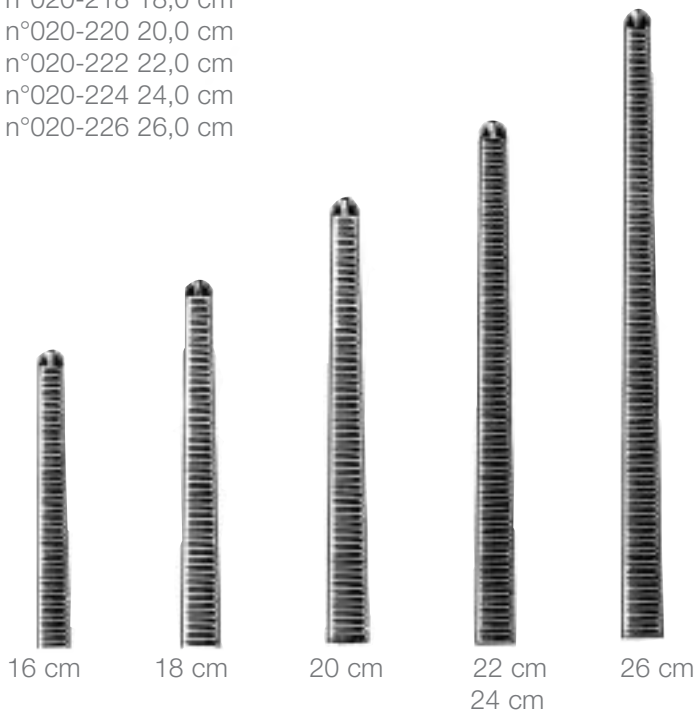

KOCHER

Curved - courbes

Item n°020-316 16,0 cm

Item n°020-318 18,0 cm

Item n°020-320 20,0 cm

Item n°020-322 22,0 cm

Item n°020-324 24,0 cm

Item n°020-326 26,0 cm



Clamp forceps



Item n°030-421

Item n°030-521



FAURE
21 cm



Item n°030-025
25 cm

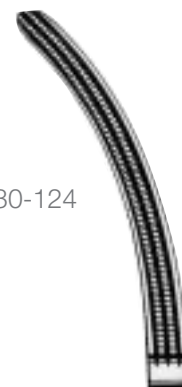

Item n°030-124
24,5 cm

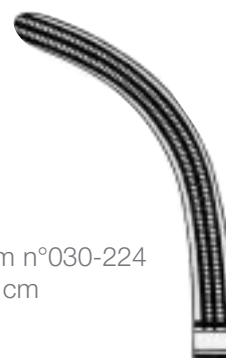

Item n°030-224
24 cm



Item n°030-323
23 cm



GREEN-ARMYTAGE
Item n° 030-622
22 cm



WERTHEIM

Special Hysterectomy Clamps

Straight w/ Gold Rings

- 336-411 21cm
- 336-541 24cm
- 336-601 30cm
- 336-661 35cm



Angulated w/ Gold Ring

- 336-414 21cm
- 336-544 24cm
- 336-604 30cm
- 336-664 35cm

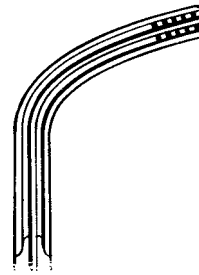

Slightly Curved w/ Gold Ring

- 336-412 21cm
- 336-542 24cm
- 336-602 30cm
- 336-662 35cm

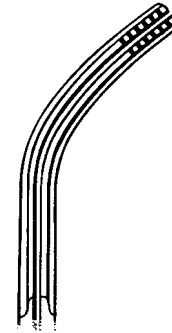

Strongly Curved w/ Gold Rings

- 336-413 21cm
- 336-543 24cm
- 336-603
- 336-663

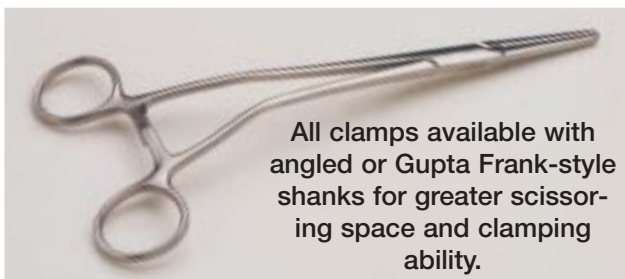
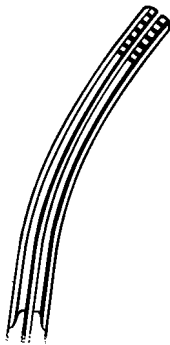

These clamps are well-balanced and have a sturdy, atraumatic longitudinal groove that guarantees a secure grip of tissue and prevents slippage. The hysterectomy clamps are available in four lengths and four jaw configurations.

Vaginal speculums



BREISKY
29 cm
160-350 100x20mm
160-351 100x25mm
160-352 100x30mm
160-353 100x35mm
160-354 100x40mm

BREISKY
32 cm
160-355 130x20mm
160-356 130x25mm
160-357 130x30mm
160-358 130x35mm
160-359 130x40mm

BREISKY
35 cm
160-360 160x20mm
160-361 160x25mm
160-362 160x30mm
160-363 160x35mm
160-364 160x40mm

BREISKY
37 cm
160-365 180x20mm
160-366 180x25mm
160-367 180x30mm
160-368 180x35mm
160-369 180x40mm

Vaginal speculums and retractors



DOYEN

24 cm

Item n° 160-310 60x35mm
Item n° 160-311 90x35mm
Item n° 160-312 120x35mm
Item n° 160-313 140x35mm
Item n° 160-314 160x35mm
Item n° 160-315 180x35mm

Item n° 160-316 60x45mm
Item n° 160-317 90x45mm
Item n° 160-318 120x45mm
Item n° 160-319 140x45mm
Item n° 160-320 160x45mm
Item n° 160-321 180x45mm

Item n° 160-322 60x60mm
Item n° 160-323 90x60mm
Item n° 160-324 120x60mm
Item n° 160-325 140x60mm
Item n° 160-326 160x60mm
Item n° 160-327 180x60mm



SIMON

28 cm

Item n° 160-300 115x22mm

Item n° 160-301 115x27mm

Needle holders with tungsten carbide insert jaws

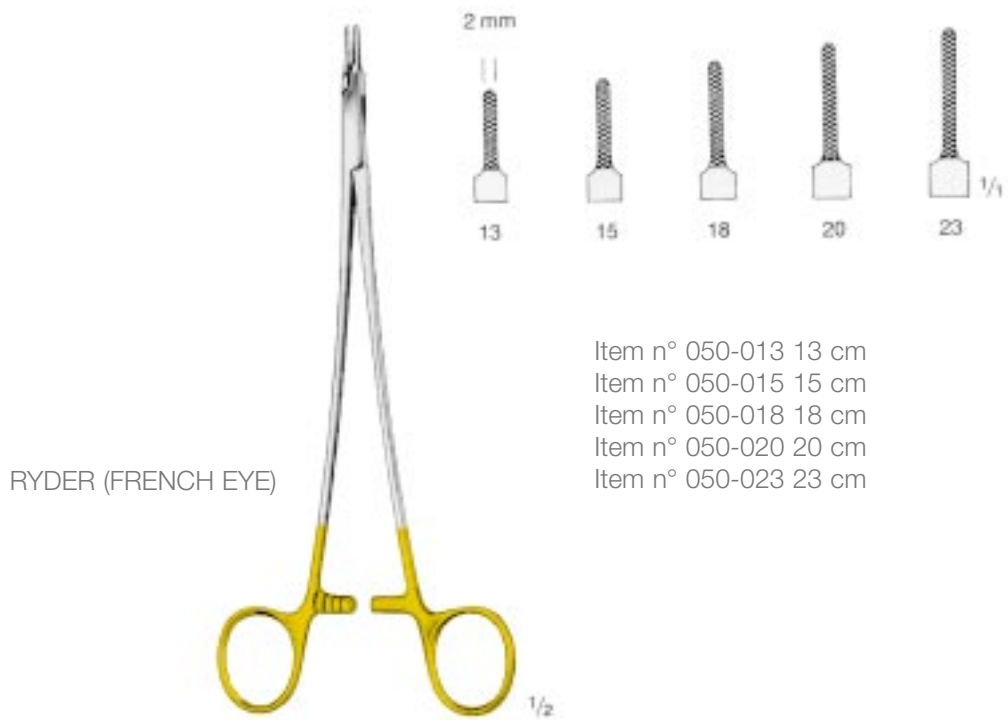

- Item n° 050-013 13 cm
- Item n° 050-015 15 cm
- Item n° 050-018 18 cm
- Item n° 050-020 20 cm
- Item n° 050-023 23 cm

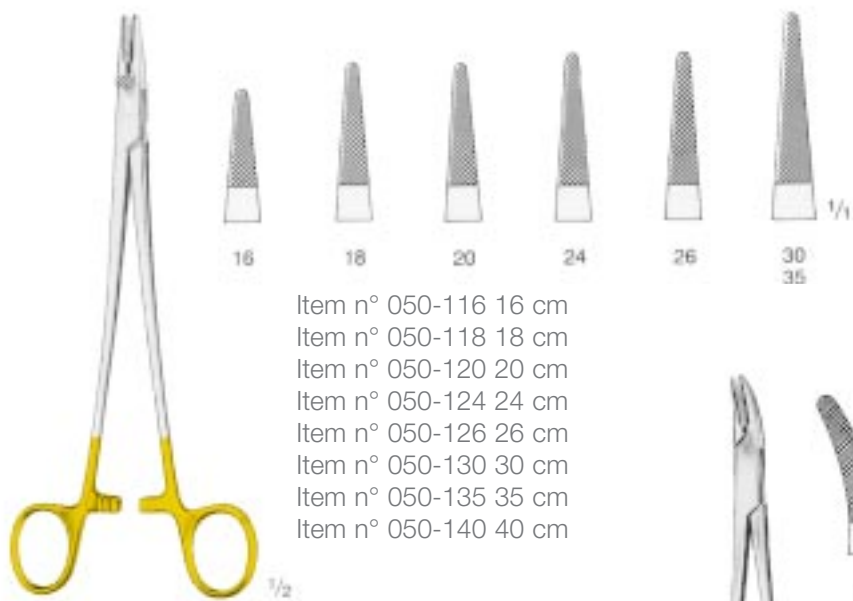

- Item n° 050-116 16 cm
- Item n° 050-118 18 cm
- Item n° 050-120 20 cm
- Item n° 050-124 24 cm
- Item n° 050-126 26 cm
- Item n° 050-130 30 cm
- Item n° 050-135 35 cm
- Item n° 050-140 40 cm

MAYO-HEGAR



- Item n° 050-220 20 cm
- Item n° 050-224 24 cm
- Item n° 050-226 26 cm

MAYO-HEGAR (HEANEY)

Needle holders with tungsten carbide insert jaws



HALSEY
Item n° 050-001
13,5cm



CRILE-WOOD
Item n°050-315
15cm

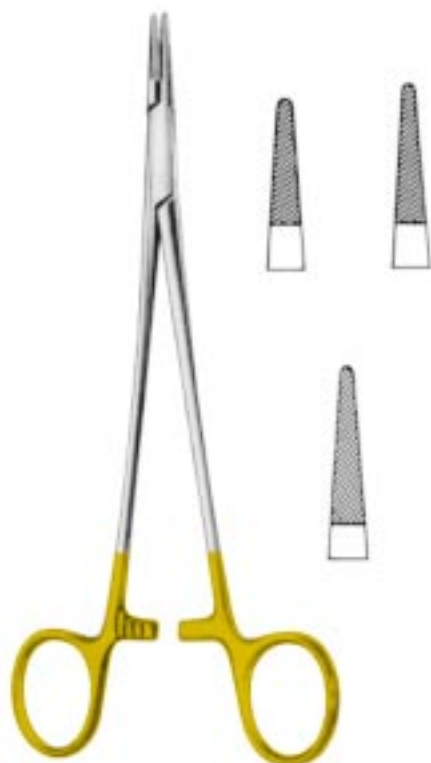

CRILE-WOOD (De Bakey)
Item n° 050-318 - 18cm
Item n° 050-320 - 20cm
Item n° 050-323 - 23cm

Monopolar insulated forceps and scissors



MAYO
Item n°

170-101 - 20cm
170-102 - 23cm



MAYO
Item n°

170-103 - 20cm
170-104 - 23cm



METZENBAUM
Item n°

170-105 - 18cm
170-106 - 20cm
170-107 - 23cm



Monopolar
cable for these
instruments.
Item n°170-108



GERALD
Item n°
170-005
18cm



GERALD
Item n°
170-006
18cm
(1 x 2)



Item n°
170-007-
18cm
170-008-
20cm
170-009-
25cm



DISSECTING
FORCEPS
SERRATED
Item n°
170-001-18cm
170-002-21cm
170-003-25cm
2mm tip width



ADSON BAYONET
SERRATED
Item n°
170-004-19cm
Long
2mm tip width

Look
inside

Comprehensive Family of Products for Operating Room and Private Offices

- Full range of electrosurgery electrodes developed and manufactured in house for all applications including gyn, dermatology, gen surgery, cardio vascular, marillo-facial...
- LapMan[®] robot for laparoscope manipulation.
 - Speciality biopsy forceps
- Next 200 electrosurgical generator and all its accessories.
- Large range of hysterectomy clamps and scissors
 - Endometrial Samplers.
- Os finder, flexible and gentle cervical dilator for hysterectomy, endometrial biopsy...
- High quality needle holders with tungsten carbide insert jaws.

Medsys s.a. • 39, rue Chainisse
B-5030 Gembloux • Belgium
Tel. : +32 81 56 84 84 • Fax : +32 81 56 88 84
E-mail : medsys@skynet.be
[http:// www.medsys.be](http://www.medsys.be)

